

# AUGUSTAFLEX®



## SAEDI. INNOVATION AND QUALITY FROM ALTO ADIGE.

The engineering company SAEDI Srl was founded in 2012 in Sarentino (Alto Adige, Italy) in order to develop road sign poles and bollards that can bend, so they are not damaged when struck by vehicles. Today, SAEDI Srl offers its innovative street furniture and road safety solutions to the public administration as well as private companies.

SAEDI is specialised in manufacturing parking bollards, road poles, arched bollards and poles for vertical road signs, with a particular focus on models featuring the patented Augustaflex® system with disc spring technology. SAEDI's customers include more than 500 municipalities and cities in Germany, Italy, Austria, Dubai, Switzerland, Russia and many more.





# THE ISSUE OF BOLLARD DAMAGE. AN URGENT PROBLEM IN CITIES.

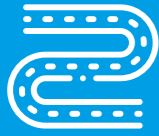

Unpleasant urban and road appearance



Maintenance and repair costs



Traffic hazard

Every urban space has thousands of signs, poles and bollards spread throughout the landscape, and their maintenance is a top priority for any urban centre. Unfortunately, damage to bollards and sign poles becomes a continuous cycle, which is typically quite costly for the public administration, not only in terms of materials to be used, but also personnel.



## CRITICAL AREAS OF THE ROAD. CONTINUOUS MAINTENANCE.

Every city or municipality has “critical” and “sensitive” areas with higher risk of the road infrastructure damage. These areas are typically those about which city councils receive recurring reports throughout the year. They include not only areas with narrow, confined roads, but also anywhere with car parks, cargo loading and unloading areas, city centres and popular tourism sites. It is amazing to think that in Zurich, Switzerland, roughly 800 bollards are replaced every year.



## WHAT IS LIFE CYCLE COSTING AND WHY IS IT IMPORTANT?

Life Cycle Costing makes it possible to assess costs throughout the entire life cycle of a product and enables public administrations to make more economically and environmentally sustainable purchases. Every single administration must necessarily take into consideration not only the expense of purchasing bollards, but also **the cost of their maintenance or repair, which is often exponentially higher than the initial purchase cost.**



## COSTS ASSOCIATED WITH BOLLARDS

The installation cost may be many times higher than the cost of the bollard itself

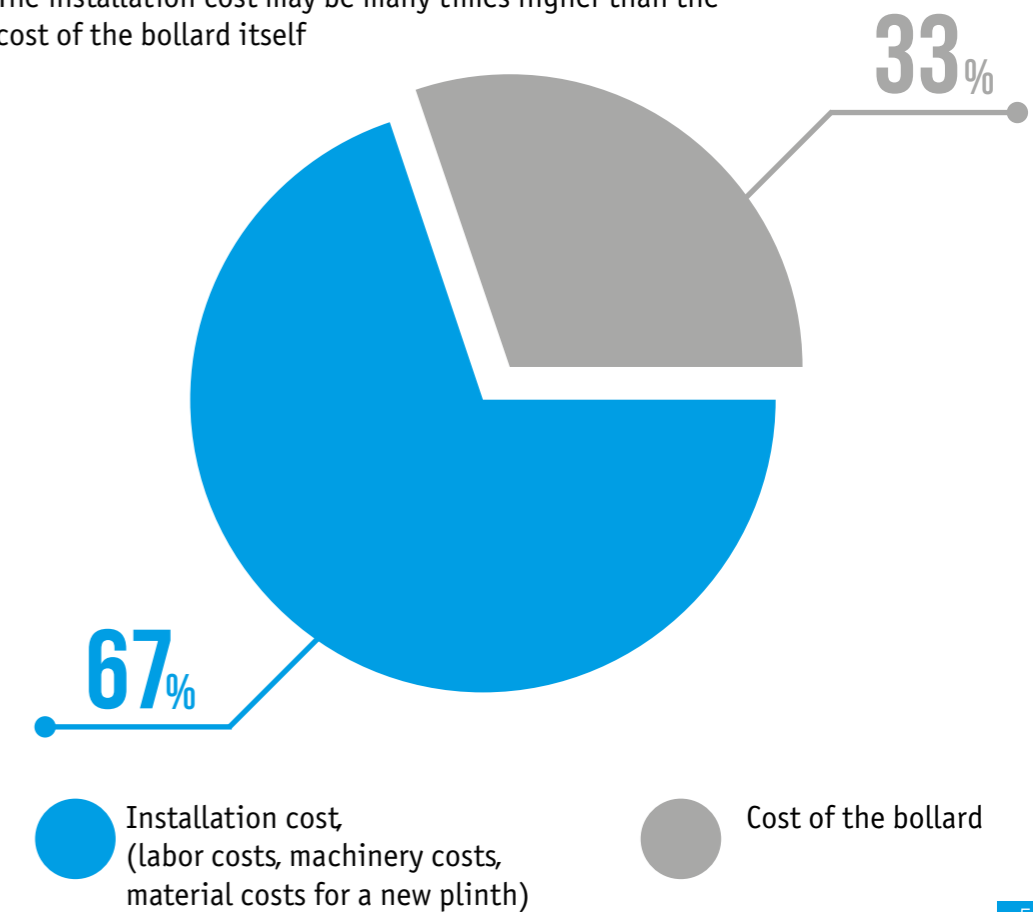



# THE LONGEST-LASTING AND SAFEST BOLLARD IN THE MARKET.

**Augustaflex® impact resistant steel bollards** are an extremely long-lasting and cost effective solution for safe, tidy and aesthetically cutting-edge streets and car parks. Thanks to the patented Augustaflex® system featuring disc springs, the bollards bend in any direction if they are hit by cars or bumped up against during clumsy parking manoeuvres, so over **the years they do not require even a minimal amount of maintenance, considerably improving street appearance and safety.**

## AUGUSTAFLEX® FLEXIBLE STEEL BOLLARDS



# NO MORE DAMAGED BOLLARDS AND THE REPAIR AND MAINTENANCE EXPENSES

With Augustaflex®, it is now possible to cut the expense of repairing and maintaining damaged bollards, an increasingly urgent issue that so often imposes very high costs on individual municipal administrations or car park operators.

## INITIAL COST VS COST OF MAINTENANCE OVER THE YEARS

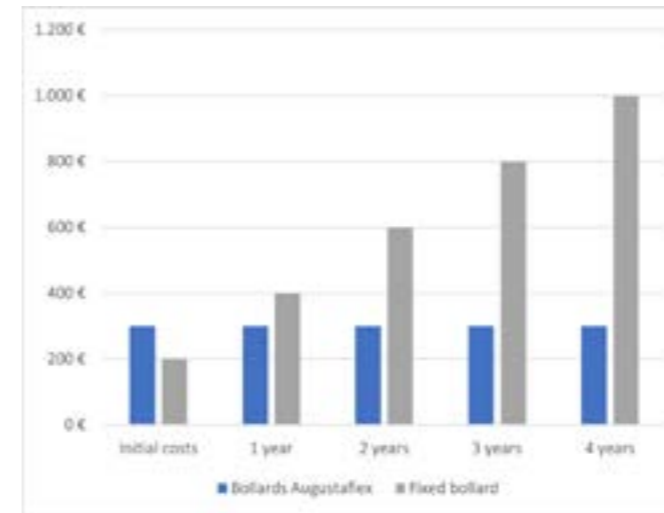

The estimate: One bollard repair per year

**ASIDE FROM PROVIDING FINANCIAL SAVINGS, AUGUSTAFLEX® BOLLARDS ALSO BOOST ROAD SAFETY AND THE TIDY, ORDERLY APPEARANCE OF CITIES.**

## DESIGN, AESTHETICS AND ELEGANCE OF STEEL.

The bollards with the Augustaflex® system are made of steel or stainless steel, materials that have always been the most valued and used in urban planning and architecture due to their appearance and longevity. Steel bollards blend in perfectly with any type of architectural surroundings, representing the perfect combination of aesthetics, function and sustainability, the top objectives of any street furniture project.

## PERFECT TO ENSURE SAFETY AND PROTECTION.

### STYLISH SECURITY.

The degree of rigidity of Augustaflex® bollards to impacts has been studied and scientifically calibrated, making them the perfect solution for preventing parking or vehicle transit in specific areas, as well as ensuring pedestrian safety. The patented Augustaflex® is sturdy on impact, the bollards remain upright even in the event of vandalism or human interactions.





# VALUE FOR URBAN PROJECTS. SUSTAINABILITY AND LONGEVITY.

Urban planning projects featuring Augustaflex® bollards **maintain their integrity and appearance over the years.** This is why their use is particularly advisable not only **in the most critical areas, but especially in city centres, near public buildings and in areas with high levels of tourism.** Augustaflex® spring bollards stand out due to their longer life cycle, which also makes them more sustainable.



## BENEFITS.

NEAT AND ORDERLY APPEARANCE OF ROADS OVER THE YEARS

LOWER MAINTENANCE EXPENSES

BETTER ROAD SAFETY

SUSTAINABILITY, LONGER LIFE CYCLE

ELEGANCE, QUALITY AND AESTHETICS OF STEEL



FOR AREAS OF TOURIST INTEREST

## 5-YEAR GUARANTEE.

FOR CONDOMINIUMS, HOTELS



FOR CITY COUNCILS



FOR SHOPPING MALLS



FOR THE CITY CENTERS







# CHURCH

ART. ARCH60, ARCH76



 D60mm / D76mm  
 Standard height:  
 100 cm above ground



 Material: galvanised and powder coated steel  
 Colour: charcoal grey



# CLAUDIA

ART. ARCL60, ARCL76

 D60mm / D76mm  
 Standard height:  
 100 cm above ground

 Material: galvanised and powder coated steel  
 Colore: antracite

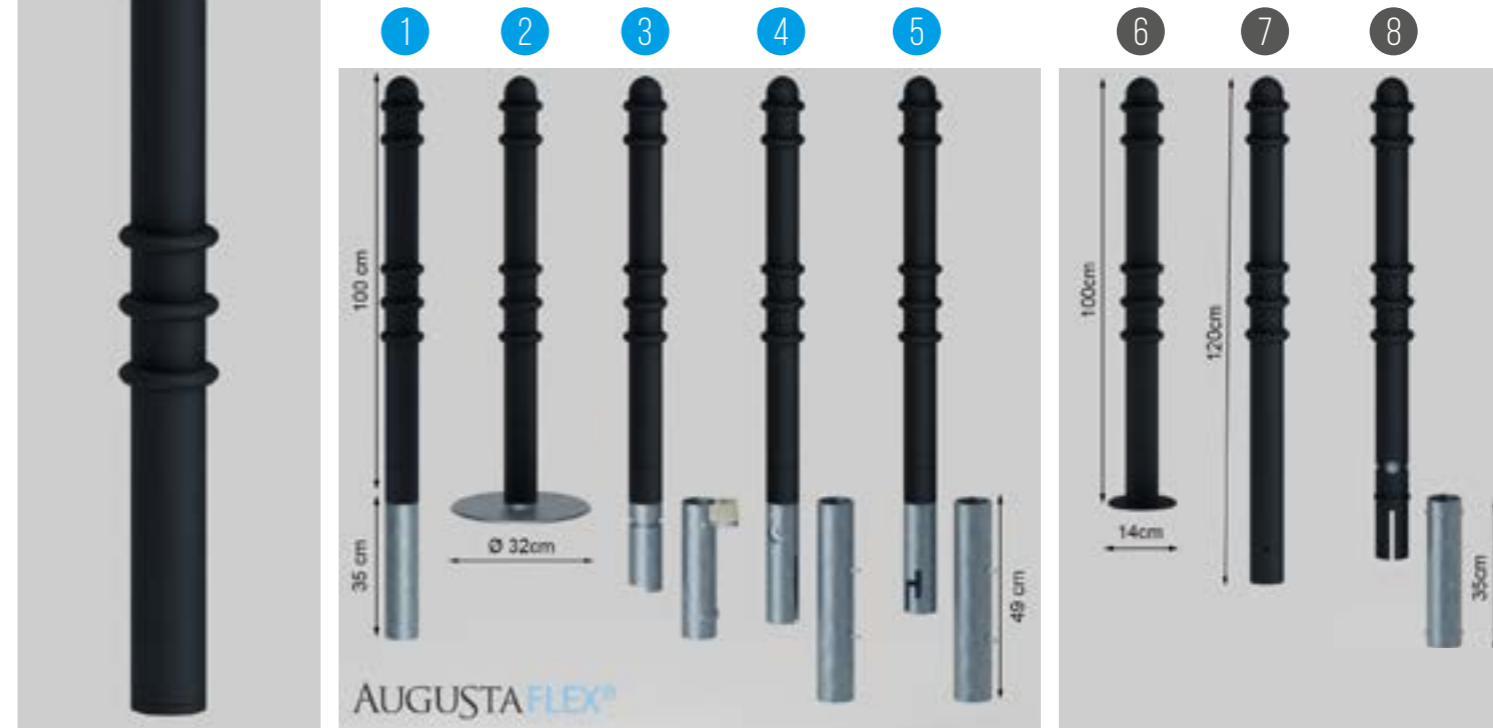

## AUGUSTAFLEX®. STEEL BOLLARDS WITH INTEGRATED FLEXIBLE SYSTEM

### 5-YEAR GUARANTEE.

1. Bollard with threaded ground sleeve to be cemented.
2. Bollard with ground plate and eight anchor bolts for concrete surfaces.

### REMOVABLE VERSIONS

The triangular key is a universal key which facilitates their removal in urgent situations by fire brigades, the police, etc.

3. External triangular keylock.  
Bollard with ground sleeve to be cemented.  
The bollard can be easily removed in just a few seconds using a triangular key, by turning the lock located at surface level. The cap for the ground sleeve is included.
4. Internal triangular keylock.  
Bollard with ground sleeve to be cemented.  
The internal triangular keylock is accessible after raising the bollard 15 cm from the sleeve. In the standard position, the lock is not visible. The bollard can be removed using a triangular key.
5. Bayonet closure.  
Bollard with ground sleeve to be cemented.  
The bollards can be removed with no special equipment or key, by twisting it out of the slots on the lower part of the bollard. The cap for the ground sleeve is provided as an accessory.

## STEEL BOLLARDS WITHOUT AUGUSTAFLEX®. FIXED.

6. Bollard with base plate for concrete surfaces.
7. Bollard to be cemented.

### REMOVABLE WITH TRIANGULAR LOCK



8. Bollards that can be removed using a triangular key, with sleeve to be cemented.  
The self-closure mechanism makes it possible to remove the bollard in just a few seconds using a triangular key, sleeve included.





Aesthetically, Augustaflex® bollards look no different from conventional fixed steel ones, so within one project or installation, different versions may be used: flexible with Augustaflex® and conventional fixed or removable, with the Augustaflex® bollards used in more critical areas with a high risk of damage.

# DORIA

ART. ARD060, ARD076

 D60mm / D76mm  
 Standard height:  
 100 cm above ground

 Material: galvanised and powder coated steel  
 Colore: antracite

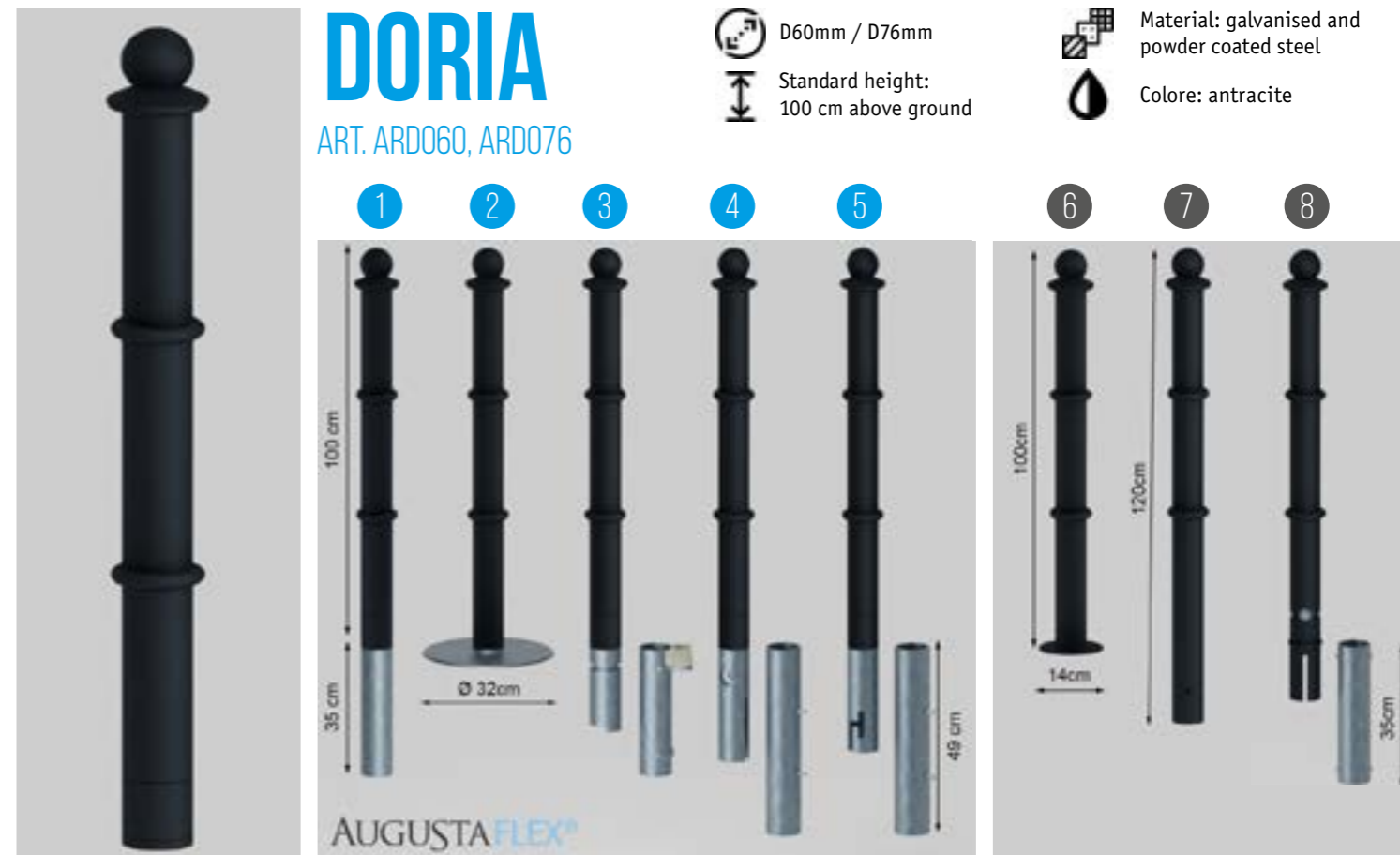

# OLLI BLACK

ART. AROL60, AROL76

D60mm / D76mm  
Standard height:  
100 cm above ground

Material: galvanised and powder coated steel  
Colour: shiny black  
Reflective strips, 2 x 20 cm

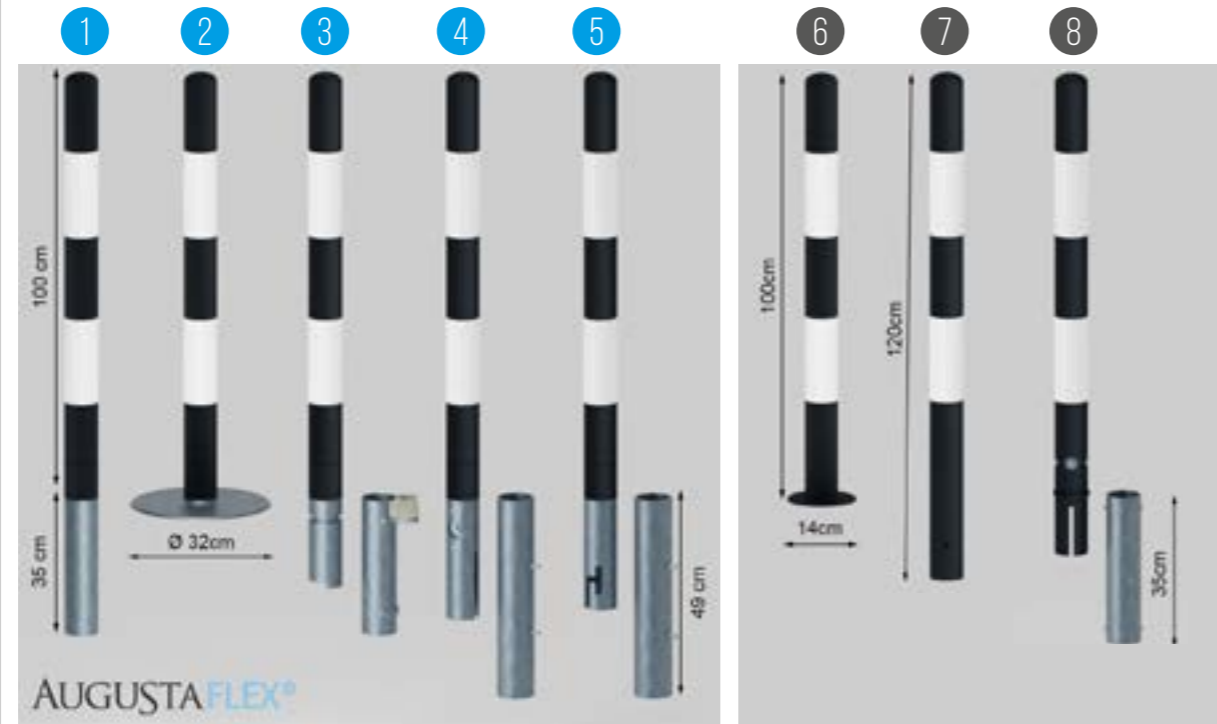

# OLLI RED

ART. AROL60, AROL76

D60mm / D76mm  
Standard height:  
100 cm above ground

Material: galvanised and powder coated steel  
Colour: shiny red  
Reflective strips, 2 x 20 cm

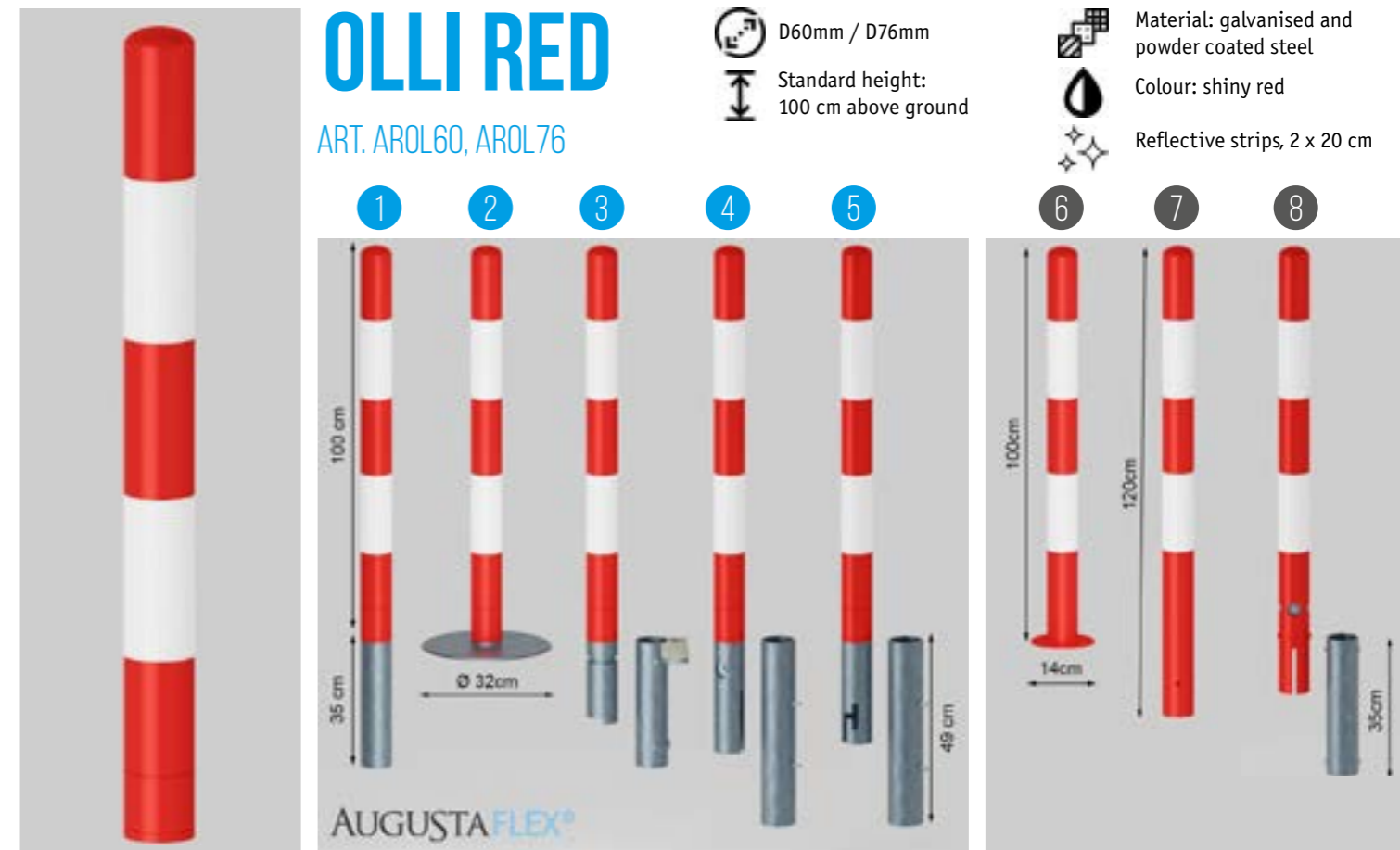

## AUGUSTAFLEX®. DISSUASORI IN ACCIAIO CON SISTEMA FLESSIBILE INTEGRATO

5-YEAR GUARANTEE.

1. Bollard with threaded ground sleeve to be cemented.
2. Bollard with ground plate and eight anchor bolts for concrete surfaces.

### REMOVABLE VERSIONS

The triangular key is a universal key which facilitates their removal in urgent situations by fire brigades, the police, etc.

3. External triangular keylock.  
Bollard with ground sleeve to be cemented.  
The bollard can be easily removed in just a few seconds using a triangular key, by turning the lock located at surface level. The cap for the ground sleeve is included.
4. Internal triangular keylock.  
Bollard with ground sleeve to be cemented.  
The internal triangular keylock is accessible after raising the bollard 15 cm from the sleeve. In the standard position, the lock is not visible. The bollard can be removed using a triangular key.
5. Bayonet closure.  
Bollard with ground sleeve to be cemented.  
The bollards can be removed with no special equipment or key, by twisting it out of the slots on the lower part of the bollard. The cap for the ground sleeve is provided as an accessory.

## STEEL BOLLARDS WITHOUT AUGUSTAFLEX®. FIXED.

6. Bollard with base plate for concrete surfaces.
7. Bollard to be cemented.

### REMOVABLE WITH TRIANGULAR LOCK

8. Bollards that can be removed using a triangular key, with sleeve to be cemented.  
The self-closure mechanism makes it possible to remove the bollard in just a few seconds using a triangular key, sleeve included.



Aesthetically, Augustaflex® bollards look no different from conventional fixed steel ones, so within one project or installation, different versions may be used: flexible with Augustaflex® and conventional fixed or removable, with the Augustaflex® bollards used in more critical areas with a high risk of damage.

# OLLI YELLOW

ART. AROL60, AROL76

D60mm / D76mm  
Standard height:  
100 cm above ground

Material: galvanised and powder coated steel  
Colour: shiny yellow  
Reflective strips, 2 x 20 cm

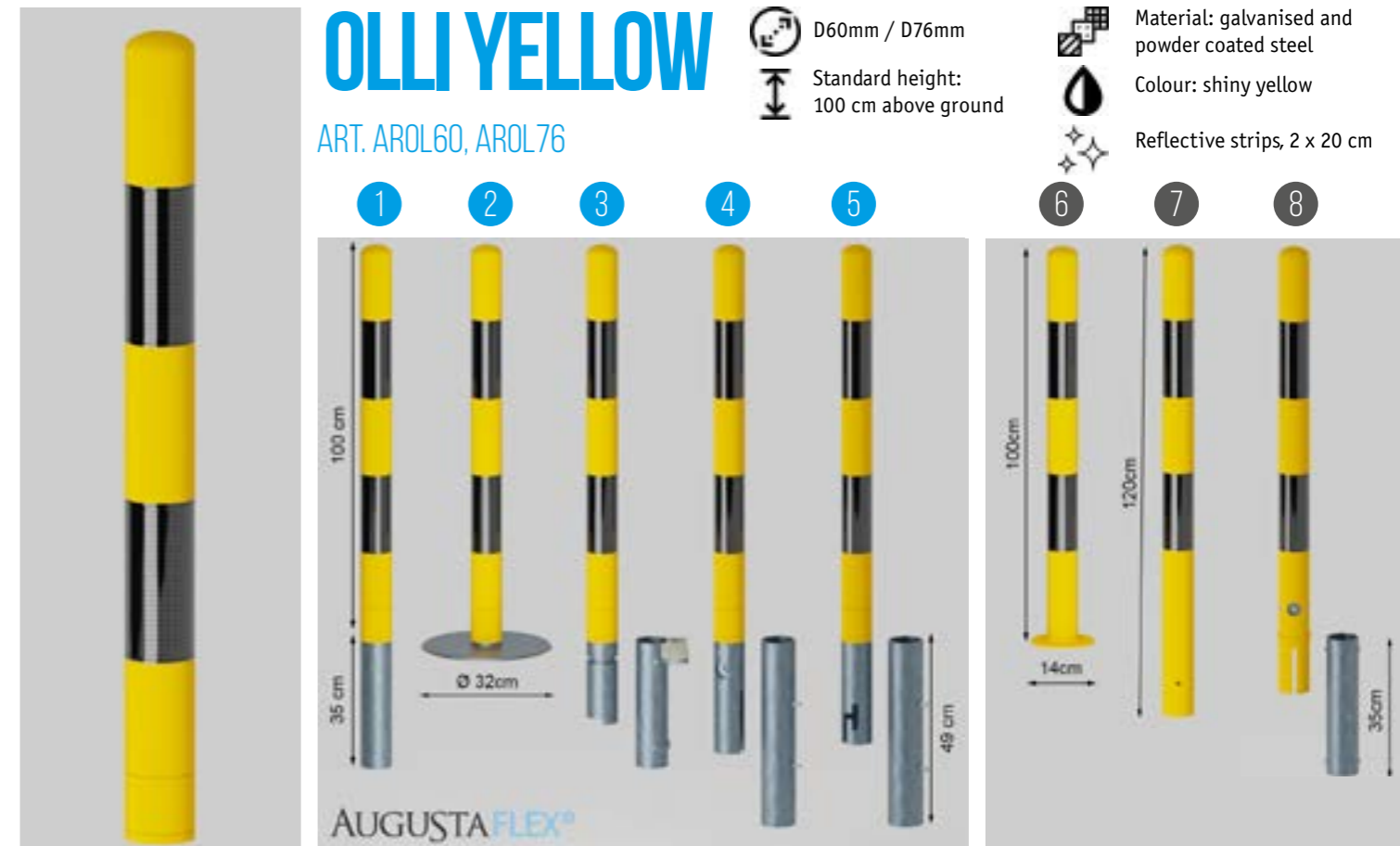

See page 18 to discover the bollard customisation possibilities and to view a list of accessories.



# CHAMPS ELYSEES

D60mm  
Standard height:  
120 cm above ground  
ART. ARCL60, ARCL76

Material: galvanised and powder coated steel  
Colour: charcoal grey, charcoal grey and white  
Variant with white head



# GEORGE

ART. ARGE60, ARGE76

D60mm / D76mm  
Standard height:  
100 cm above ground

Material: galvanised and powder coated steel  
Colour: charcoal grey, charcoal grey and white  
Variant with white head



## AUGUSTAFLEX®. DISSUASORI IN ACCIAIO CON SISTEMA FLESSIBILE INTEGRATO

5-YEAR GUARANTEE.

1. Bollard with threaded ground sleeve to be cemented.
2. Bollard with ground plate and eight anchor bolts for concrete surfaces.

### REMOVABLE VERSIONS

The triangular key is a universal key which facilitates their removal in urgent situations by fire brigades, the police, etc.

3. External triangular keylock.  
Bollard with ground sleeve to be cemented.  
The bollard can be easily removed in just a few seconds using a triangular key, by turning the lock located at surface level. The cap for the ground sleeve is included.
4. Internal triangular keylock.  
Bollard with ground sleeve to be cemented.  
The internal triangular keylock is accessible after raising the bollard 15 cm from the sleeve. In the standard position, the lock is not visible. The bollard can be removed using a triangular key.
5. Bayonet closure.  
Bollard with ground sleeve to be cemented.  
The bollards can be removed with no special equipment or key, by twisting it out of the slots on the lower part of the bollard. The cap for the ground sleeve is provided as an accessory.

## STEEL BOLLARDS WITHOUT AUGUSTAFLEX®. FIXED.

6. Bollard with base plate for concrete surfaces.
7. Bollard to be cemented.

### REMOVABLE WITH TRIANGULAR LOCK

8. Bollards that can be removed using a triangular key, with sleeve to be cemented.  
The self-closure mechanism makes it possible to remove the bollard in just a few seconds using a triangular key, sleeve included.



Aesthetically, Augustaflex® bollards look no different from conventional fixed steel ones, so within one project or installation, different versions may be used: flexible with Augustaflex® and conventional fixed or removable, with the Augustaflex® bollards used in more critical areas with a high risk of damage.

# NINA

ART. ARNI60, ARNI76

D60mm / D76mm  
Standard height:  
100 cm above ground

Material: galvanised and powder coated steel  
Colore: antracite

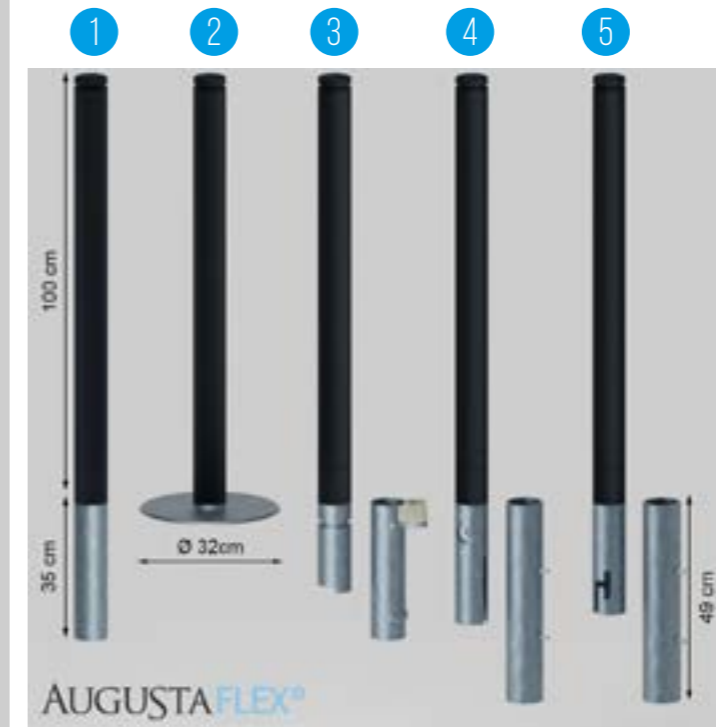



See page 18 to discover the bollard customisation possibilities and to view a list of accessories.

# ISEMAR

ART. ARIS60, ARIS76

 D60mm / D76mm  
 Standard height:  
 100 cm above ground

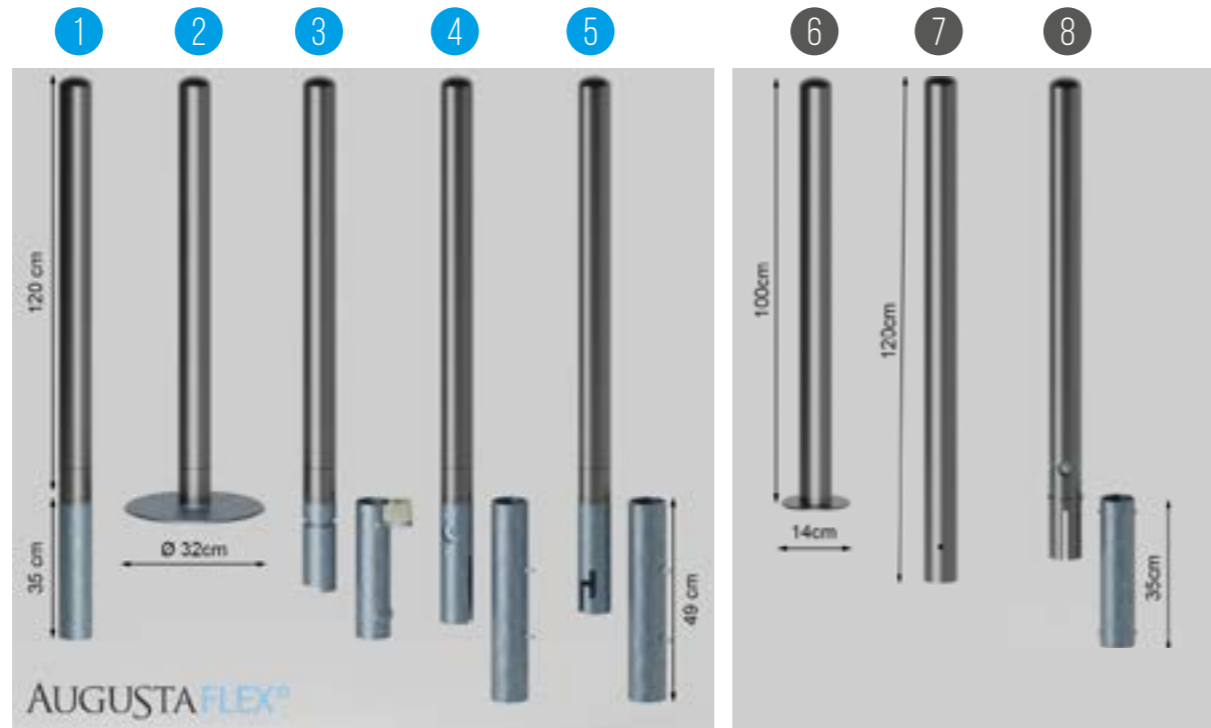

 Material: stainless steel  
 Colore: acciaio grigio



# ZIRCO

ART. ARZI60, ARZI76

 D60mm / D76mm  
 Standard height:  
 100 cm above ground

 Material: stainless steel  
 Colore: acciaio grigio



## AUGUSTAFLEX®. DISSUASORI IN ACCIAIO CON SISTEMA FLESSIBILE INTEGRATO

5-YEAR GUARANTEE.

1. Bollard with threaded ground sleeve to be cemented.
2. Bollard with ground plate and eight anchor bolts for concrete surfaces.

### REMOVABLE VERSIONS

The triangular key is a universal key which facilitates their removal in urgent situations by fire brigades, the police, etc.

3. External triangular keylock.  
Bollard with ground sleeve to be cemented.  
The bollard can be easily removed in just a few seconds using a triangular key, by turning the lock located at surface level. The cap for the ground sleeve is included.
4. Internal triangular keylock.  
Bollard with ground sleeve to be cemented.  
The internal triangular keylock is accessible after raising the bollard 15 cm from the sleeve. In the standard position, the lock is not visible. The bollard can be removed using a triangular key.
5. Bayonet closure.  
Bollard with ground sleeve to be cemented.  
The bollards can be removed with no special equipment or key, by twisting it out of the slots on the lower part of the bollard. The cap for the ground sleeve is provided as an accessory.

## STEEL BOLLARDS WITHOUT AUGUSTAFLEX®. FIXED.

6. Bollard with base plate for concrete surfaces.
7. Bollard to be cemented.

### REMOVABLE WITH TRIANGULAR LOCK



8. Bollards that can be removed using a triangular key, with sleeve to be cemented.  
The self-closure mechanism makes it possible to remove the bollard in just a few seconds using a triangular key, sleeve included.





Aesthetically, Augustaflex® bollards look no different from conventional fixed steel ones, so within one project or installation, different versions may be used: flexible with Augustaflex® and conventional fixed or removable, with the Augustaflex® bollards used in more critical areas with a high risk of damage.

# GLORIA

ART. ARGL60, ARGL76

 D60mm / D76mm  
 Standard height:  
 100 cm above ground

 Galvanised and powder coated steel  
 Colore: antracite



See page 18 to discover the bollard customisation possibilities and to view a list of accessories.



# EQUIPMENT

**HOOK SPANNER**  **D60/D76 MM**

for the installation of the Augustaflex® with threaded ground sleeve or ground plate.



## TRIANGULAR KEY

to remove the bollards with the triangular key lock.



# CAPS

## CAP I

for threaded ground sleeve



# CUSTOMISATION

## RAL COLOURS



## CAP II

for ground sleeve of removable Augustaflex® bollards with external closure, included



## REFLECTIVE STRIPS



## CAP III

for removable bollards without Augustaflex® and for Augustaflex® bollards with internal triangular keylock and bayonet closure.



## STEEL RINGS AND CHAIN



# EXAMPLES OF CUSTOM BOLLARDS



## CUSTOM DESIGN

Our technical department is always at your disposal to create customized bollards according to your requests and needs.



## REQUEST



## STUDY AND DESIGN



## PRICE CALCULATION



## PRODUCTION

AUGUSTAFLEX®



# CONTACTS:

SAEDI LTD  
Grosso, Production zone 48/B, Sarentino, 39058  
Italy - Alto Adige (BZ)  
PIVA 02759700210

**info@saedi-group.com**

**Tel. +39 0471 1800 359**

**www.augustaflex.com**

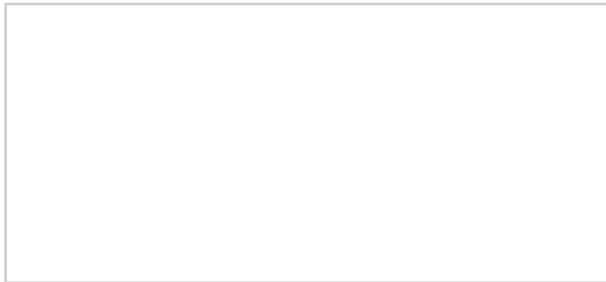

## **Request information on impact resistant posts and poles for road signs with the Augustaflex® system.**

The first and only 12899-1 certified impact resistant flexible poles for vertical road signs, designed for signs in "critical" areas and areas with intense traffic:

- flex on impact,
- do not require maintenance or repairs,
- drastically reduce maintenance costs,
- guarantee.



# AUGUSTAFLEX®